

Gaveta Openbox

Especificações:

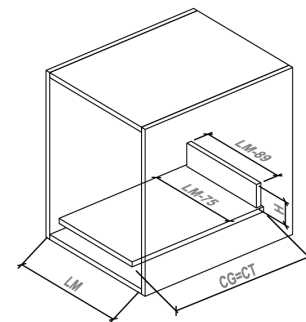

- Modelo Extração Total
- Sistema Oculto com fechamento suave
- Montagem com parafuso
- Capacidade de carga: 35kg
- Cores: prata metálico e branco
- Espessura corrediça: 1,5mm/2,0mm/1,5mm

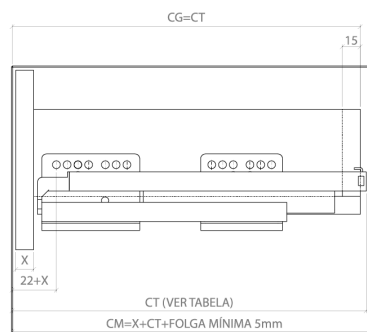
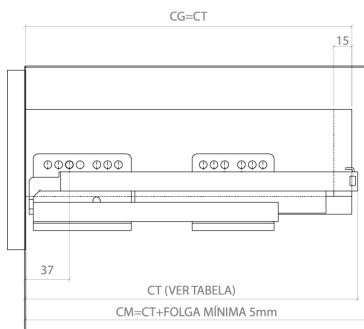

CT=COMPRIMENTO DO TRILHO
CG=COMPRIMENTO DA GAVETA
CM=COMPRIMENTO DO MÓVEL
LM = LARGURA INTERNA DO MÓVEL
X= ESPESSURA DA FRENTE DA GAVETA

TRASEIRO DA GAVETA	H (mm)
MODELO 86mm	70
MODELO 164mm	148
MODELO 204mm	188

Modelo	CT (mm)	A (mm)
400	395	224
450	445	224
500	495	224
550	545	224

← BORDA FRONTAL DO MÓVEL

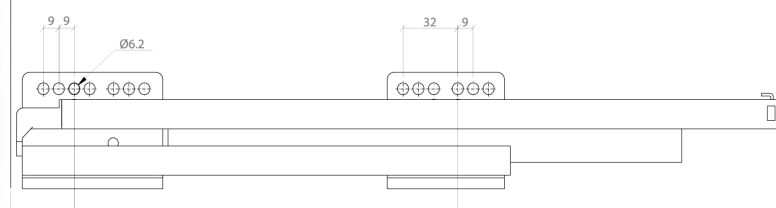

KIT EXTENSOR PARA GAVETA OPENBOX 164mm



KIT EXTENSOR PARA GAVETA OPENBOX 204mm



Com instalação rápida e eficiente, o sistema consiste em um conjunto básico de corrediças com extração total, laterais com capas de acabamento e fixadores frontais. Com os componentes opcionais e acessórios variados, são inúmeras possibilidades de design, que tornam sua aplicação universal.

DIMENSÕES PARA GAVETA OPENBOX 86mm ALTURA

DIMENSÕES DO GAVETEIRO

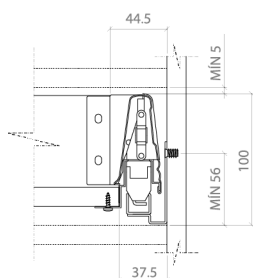

DIMENSÕES FIXADOR DA FRENTE

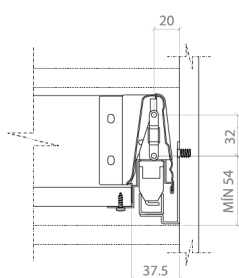

FURAÇÃO NA FRENTE DE GAVETA

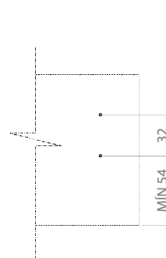

FIXAÇÃO DO TRASEIRO DA GAVETA

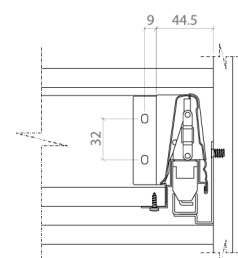

DIMENSÕES PARA GAVETA OPENBOX 164mm ALTURA

DIMENSÕES DO GAVETEIRO

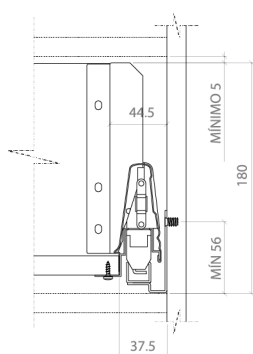

DIMENSÕES FIXADOR DA FRENTE

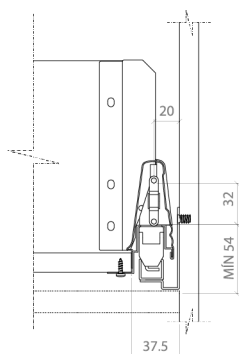

FURAÇÃO NA FRENTE DE GAVETA

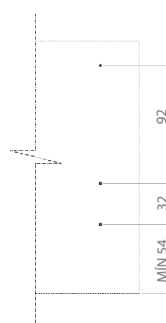

FIXAÇÃO DO TRASEIRO DA GAVETA

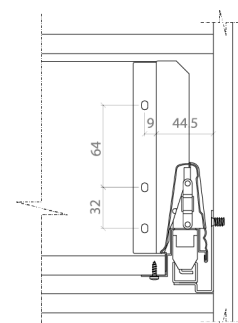

DIMENSÕES PARA GAVETA OPENBOX 204mm ALTURA

DIMENSÕES DO GAVETEIRO

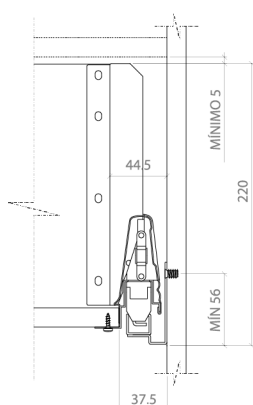

DIMENSÕES FIXADOR DA FRENTE

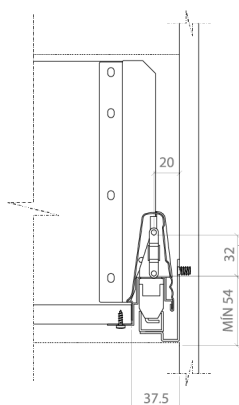

FURAÇÃO NA FRENTE DE GAVETA

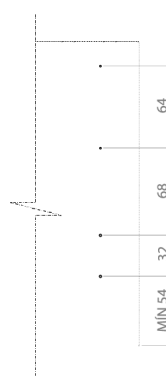

FIXAÇÃO DO TRASEIRO DA GAVETA

